

GalvinCare® CP-BS Lead Safe™ MH Ligature Resistant Basin Outlet 15 MI

PRODUCT CODES:

- 121.53.11.00

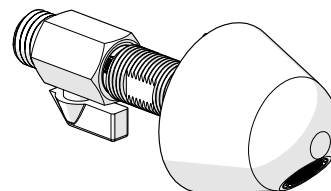

SPECIFICATIONS

- GalvinCare® Vanity Outlet tapware is designed to minimise the risk of vandalism by providing a smooth, angled conical shape body and anti-rotation locating pin.
- The outlet is supplied with a flow regulating aerator that incorporates a swivel to provide 10 degrees of flow direction adjustment (each side) when required.
- Heavy duty chrome plate finish.
- Minimizes the risk hiding of contraband.
- Lead Safe™ Brass Construction*

IMPORTANT: All GalvinCare® vanity outlet taps are tested in accordance with AS 3718 and leave our premises in good working order.

* Our Lead Safe™ product range is compliant with Lead-Free Requirements of the NCC 2022 Vol. Three, Clause A5G4(2) and NSF/ANSI 372.

** Any flow controller incorporated in the outlet to be tightened to prevent removal by hand. As per AS 3718.

WARNINGS: Special attentions to be paid on notes, photos, images, or drawings of assembly steps marked with the warning symbol.



TECHNICAL DATA

Inlet	R ½" – Male	
Outlet	Aerator	
Working Pressure Range (kPa)	Min	50
	Max	500
Working Temperature Range (°C)	Min	5
	Max	65
Nominal Flow Rate (LPM)	4.51	
Construction	Brass	
Finish	Chrome	

NOTE: Galvin Engineering continually strive to improve their products. Specifications may change without notice.

TOOLS REQUIRED

- Power drill
- Spanner or adjustable crescent
- Thread sealer/ tap
- Hex key

PRE-INSTALLATION - MOUNTING DETAILS

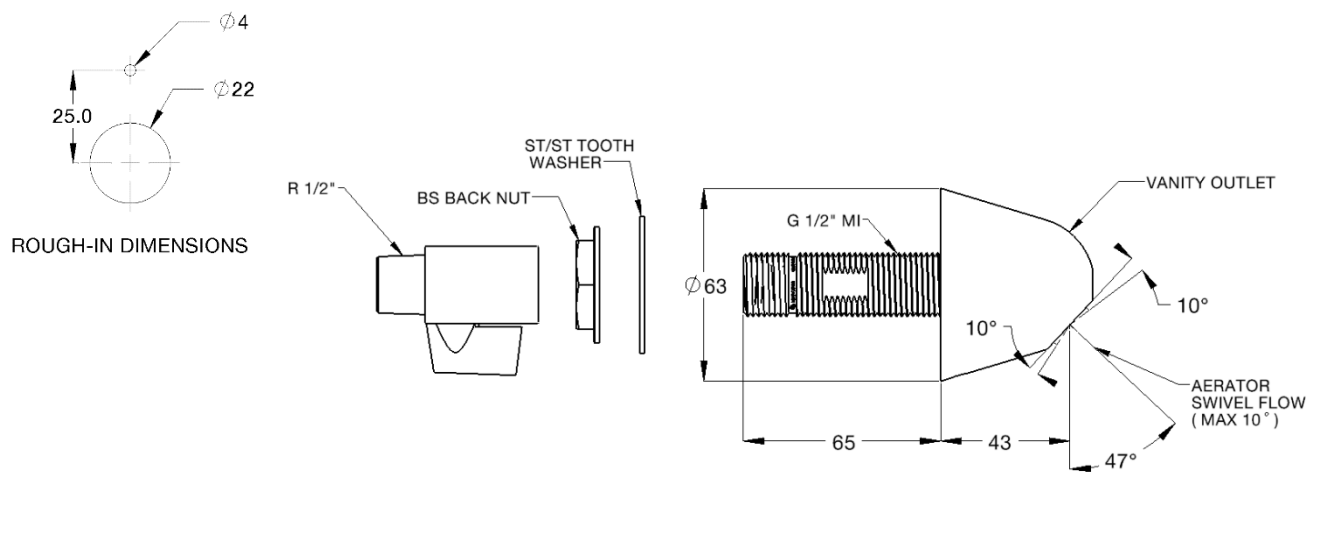

INSTALLATION

IMPORTANT: Galvin Engineering products must be installed in accordance with these installation instructions and in accordance with AS/NZS 3500, the PCA and your local regulatory requirements. Water and/or electrical supply conditions must also comply to the applicable national and/or state standards. Failing to comply with these provisions shall void the product warranty and may affect the performance of the product.

IMPORTANT: Whilst our product designs take into account a broad range of installation types and surfaces, it is important that surfaces which fixtures are mounted to are flat and free from defect. Additionally, ensure any protruding connecting thread is square to the wall so that the outlet sits flat against the wall when installed, ensuring that there are no gaps between the wall and outlet. This is especially important when installing product ranges that have been designed for correctional and health facilities, where special attention is required to minimise ligature points and areas for concealment of contraband. In addition to ensuring the products are fitted securely and in accordance with the following instructions, consideration shall be given to the use of non-pick mastics such as BASF Sonolastic "Ultra" to ensure a high quality and safe installation.

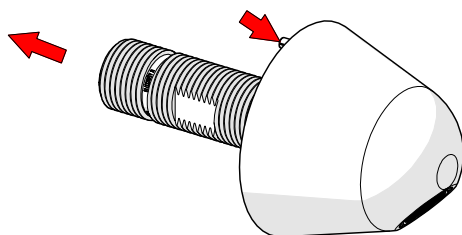

1. Fit body

- Fit the outlet into vanity.
- Ensure anti-rotation pin locates properly.

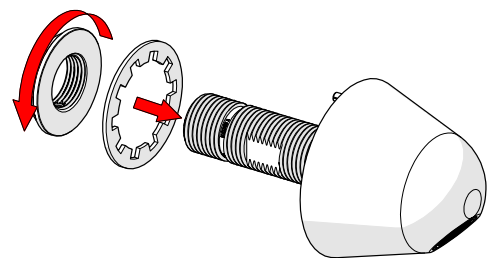

2. Secure the outlet

- Secure the body with supplied internal tooth washer and back nut.

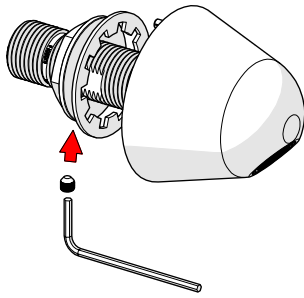

3. Fit grub screw

- Ensure stainless steel grub screw is fitted once vanity outlet has been secured by the backnut. Take care not to over-tighten.

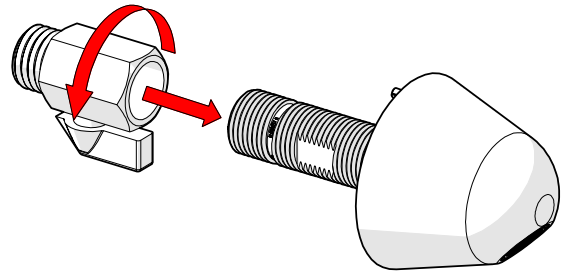

4. Fit isolation valve

- Assemble isolation valve at end of the outlet.
- Apply thread sealant or thread tape for sealing. Take care not to over-tighten.

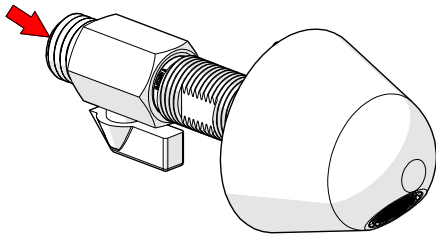

5. Connect the water line

- Connect water supply to isolation valve inlet.

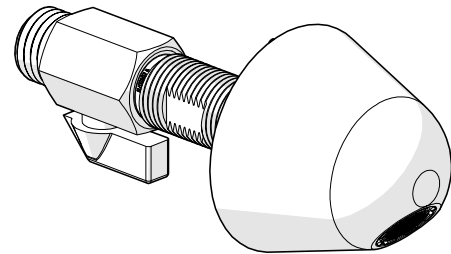

6. Testing

- Inspect the tap and check for any leaks.
- Adjust flow with isolation valve, if required.

TROUBLESHOOTING

PROBLEM	CAUSE	RECTIFICATION
Water is not flowing or inconsistent flow.	Blocked aerator.	Remove aerator from outlet and remove debris. Install an inline strainer to stop further blockages.
	Isolation valve is closed.	Open isolation valve.
	Mains supply is turned off.	Turn on mains supply.
Rate of flow inadequate.	Isolation valve not adjusted correctly.	Adjust isolation valve to achieve desired flow.

WARRANTY

Galvin Engineering products are covered under our Manufacturer's Warranty. Galvin Engineering products must be installed in accordance with the installation instructions and in accordance with AS/NZS 3500 and NCC Volume Three, relevant Australian Standards and local authorities applicable to product being installed. Water and electrical supply conditions must also comply to the applicable national and/or state standards, failing to comply with these provisions may void the product warranty and affect performance of the product.

Please visit www.galvinengineering.com.au to view the full warranty, our Installation Compliance and Maintenance & Cleaning information as well as any other additional information.

DEFINITIONS AND DISCLAIMER

Galvin Engineering manufactures a range of products marked as Ligature Resistant or Vandal Resistant. Please visit www.galvinengineering.com.au to read the definition of these terms and the disclaimer that applies to these products.